

KD40s ±2N ±5N ±10N ±20N ±50N ±100N

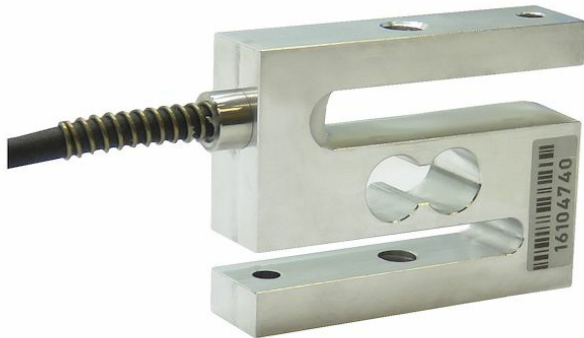

### Description

The force sensor KD40S is very well suited for testing tasks in quality assurance as well as in materials testing due to its compact construction.

Inward and outward force transmission are arranged centrally.

The force sensors KD40S up to 100N are constructed as multi-range sensors. The accuracy of 0.1% is already reached at an rated output of 0.5 mV/V. This means that the zero-point stability is 4 times higher than in a sensor with the nominal output of 2 mV/V.

The force sensor KD40S can be used up to an output signal of 2 mV/V or four times the specified nominal force.

The force sensor KD40S (up to 100 N) should be installed in such way that the outgoing cables are assigned to the immobile side of the measuring construction. Thus forces from the connecting cable do not have an influence on measurement results.

From 500N upwards the force sensors KD40s have a nominal rated output of 1.0mV/V.

They can safely be overloaded up to 1.5x their nominal force.

The cable output can be found in the middle of the two force transmission beams.

For force transfer there exists one thread M5 (up to 100N) and M6 (from 500N) in the top and bottom side of the force sensor.

Additionally there is a thread M6 (from 500N) that can be used as anti-twist protection.

The force sensor from a nominal force of 1000N has a height of 34 mm.

## Dimensions

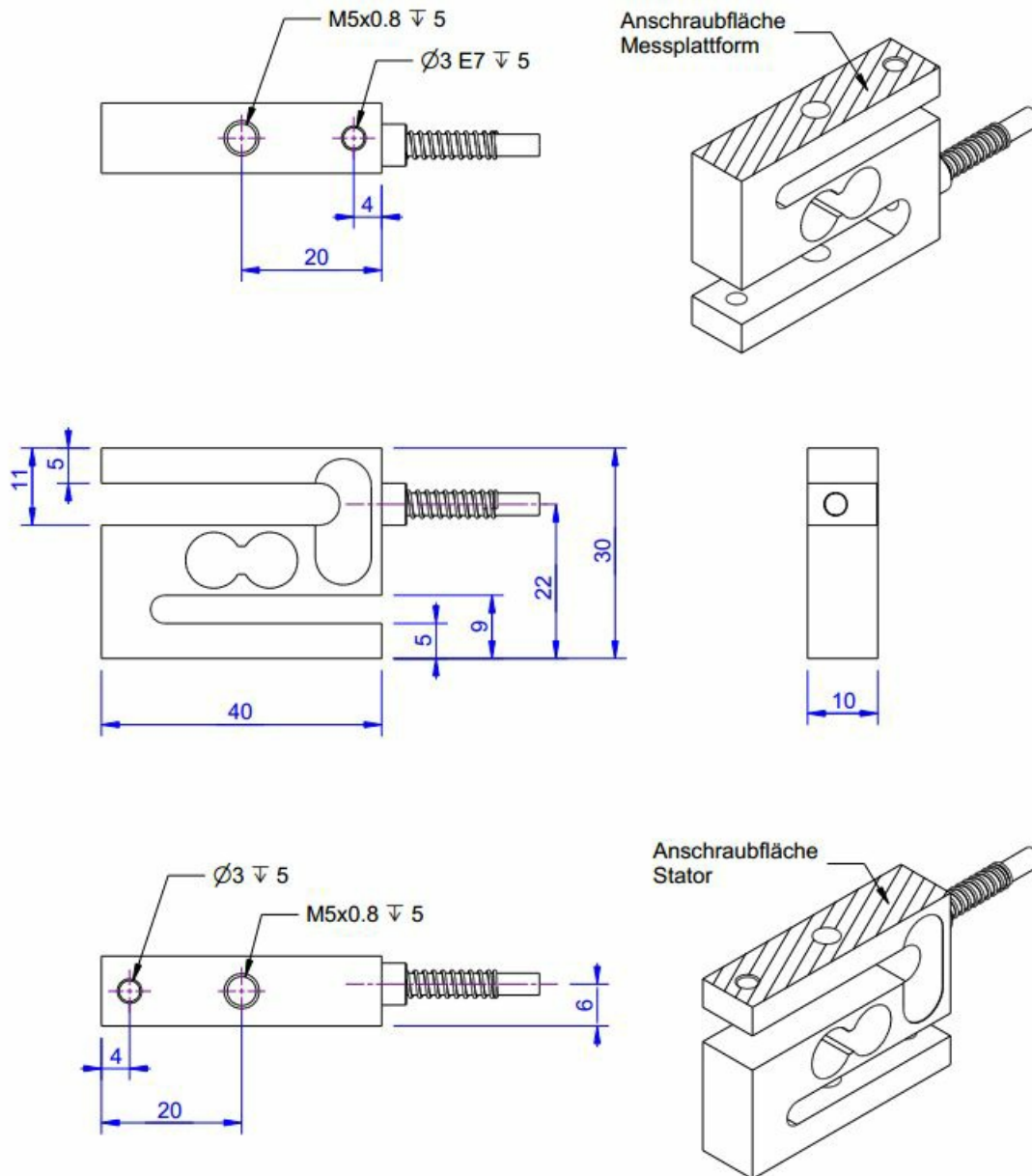

## Technical Data

### Force sensor

Type	Force sensor
Force direction	Tension / Compression
Rated force F <sub>x</sub>	N
Force introduction	Inner thread
Dimension 1	M5x0,8
Sensor Fastening	Inner thread
Dimension 2	M5x0,8
Operating force	400 %FS
Rated displacement	0.2 mm
Lateral force limit	100 %FS
Material	Aluminium alloy
Natural frequency	2 kHz
Height	30 mm
Length or Diameter	40 mm

### Electrical Data

Input resistance	390 Ohm
Tolerance input resistance	40 Ohm
Output resistance	350 Ohm
Tolerance output resistance	5 Ohm
Insulation resistance	2 GOhm
Rated range of excitation voltage f	2.5 ... 5 V
Operating range of excitation voltage f	1 ... 10 V
Zero signal	0.05 mV/V
Rated output	0.5 mV/V / FS
characteristic value range min	0.5 mV/V / FS
characteristic value range max	1 mV/V / FS

### Precision

Accuracy class	0,1%
Relative linearity error	0.02 %FS
Relative zero signal hysteresis	0.02 %FS
Temperature effect on zero signal	0.02 %FS/K
Temperature effect on characteristic value	0.01 %RD/K
Relative creep	0.1 %FS

### Connection Data

Connection type	4 conductor open
Name of the connection	ME-SYSTEME.DE / 24-4 PUR
Cable length	3 m

### Temperature

Rated temperature range f	-10 ... 70 °C
---------------------------	---------------

Operating temperature range f	-10 ... 85 °C
Storage temperature range f	-10 ... 85 °C
Environmental protection	IP65

*Abbreviation: RD: „Reading“; FS: „Full Scale“;  
The exact sensitivity is indicated in the test report;*







## Pin Configuration

Symbol	Description	Wire colour
+Us	positive bridge supply	brown
-Us	negative bridge supply	white
+Ud	positive bridge output	green
-Ud	negative bridge output	yellow

Screen - transparent.

Compressive load : positive output signal

## accessories

	Description	Description
	Calibration Certificate kn/20/5	Factory calibration certificate for force to 20 kN in accordance with DIN EN ISO / IEC 17025 for test materials monitoring according to DIN ISO 9001: 2008 with 5 load levels and 3 series of measurements.
	GSV-1H	Measuring amplifier in top-hat rail housing for sensors with strain gauges. Analogue output -10V...+10V, limiting frequency 250Hz, 4 input sensitivities from 2.0mV/V.
	GSV-2TSD-DI	Measuring amplifier in desktop-housing for sensors with strain gauges. Serial port RS232, USB port, analogue output -5V...+5V, limiting frequency 260Hz, input sensitivity 3.5mV/V.
	GSV-3USB	Measuring amplifier in aluminum housing for sensors with strain gauges. Limiting frequency 1250Hz, input sensitivity 2 / 3,5 / 10 mV/V.
	GSV-6K	Analogue measuring amplifier in plug housing for sensors with strain gauges. Analogue output configurable, TEDS, sampling frequency 10Hz ... 25kHz, input sensitivity configurable 0.1mV/V ... 8mV/V
	Calotte screwable	Screwable stop pin for force introduction for sensors KDs;