

KD80s $\pm 20\text{kN}$ - $\pm 50\text{kN}$



Description

The force sensor KD80s is used for tensile and compressive force measurements and for weighing.

The areas of application are e.g. wire rope measurements, test beds, overload securing for lifting tools, process controllers as well as weighing scales.

The force sensor KD80s for the standard temperature range will be delivered with cable Unitronic FD CP Plus 4x0,14.

The force sensor KD80s HT is used for the maximum operating temperature of 150°C. For this temperature range of 150°C the sensor will be delivered with 6-wire high temperature resistant cable ALMI HAFL-C MOD. SO 6x0,15mm².

The KD80s sensors have accuracy class of 0,05%. The environmental protection is IP65.

Dimensions

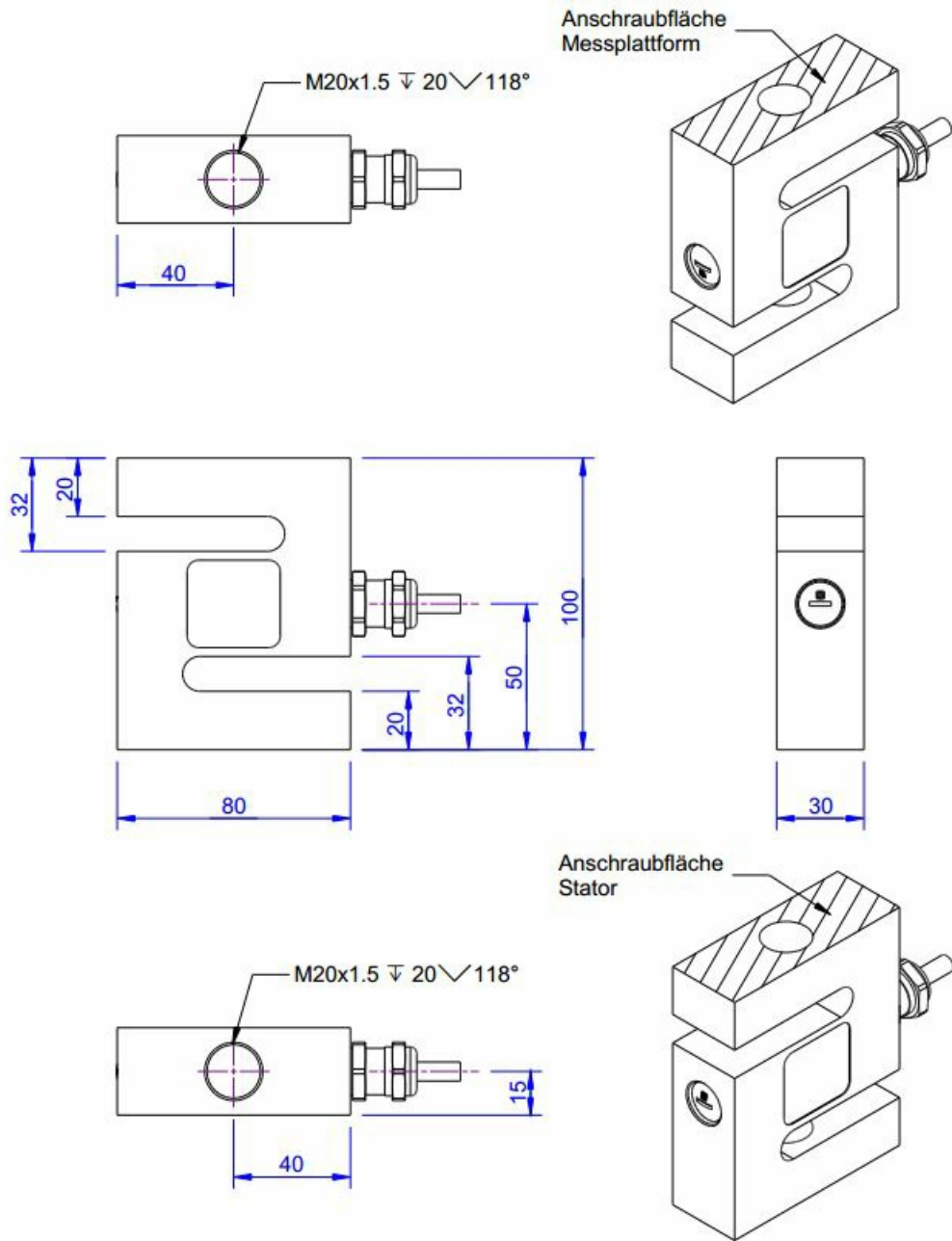

Technical Data

Force sensor

Type	Force sensor
Force direction	Tension / Compression
Rated force F _x	50 kN
Force introduction	Inner thread
Dimension 1	M20x1,5
Sensor Fastening	Inner thread
Dimension 2	M20x1,5
Operating force	150 %FS
Rated displacement	0.2 mm
Lateral force limit	100 %FS
Material	Stainless steel
Natural frequency	5 kHz
Height	100 mm
Length or Diameter	80 mm

Electrical Data

Input resistance	400 Ohm
Tolerance input resistance	50 Ohm
Output resistance	350 Ohm
Tolerance output resistance	10 Ohm
Insulation resistance	5 GOhm
Rated range of excitation voltage f	2.5 ... 5 V
Operating range of excitation voltage f	1 ... 10 V
Zero signal	0.05 mV/V
Rated output	2 mV/V / FS

Precision

Accuracy class	0,05%
Relative linearity error	0.02 %FS
Relative zero signal hysteresis	0.02 %FS
Temperature effect on zero signal	0.02 %FS/K
Temperature effect on characteristic value	0.01 %RD/K
Relative creep	0.1 %FS

Connection Data

Connection type	6 conductor open
Name of the connection	ALMI HAFL-C MOD. SO 2x2x0,25
Cable length	5 m

Temperature

Rated temperature range f	-10 ... 70 °C
Operating temperature range f	-10 ... 85 °C
Storage temperature range f	-10 ... 85 °C

Abbreviation: RD: „Reading“; FS: „Full Scale“;

1) The exact nominal sensitivity is indicated in the test report;

Pin Configuration

Symbol	Description	Wire colour
+Us	positive bridge supply	brown
-Us	negative bridge supply	white
+Ud	positive bridge output	green
-Ud	negative bridge output	yellow

Pressure load: positive output signal.







Shield- transparent.

Symbol	Description	Wire colour
+Us	positive bridge supply	brown
-Us	negative bridge supply	white
+Ud	positive bridge output	green
-Ud	negative bridge output	yellow
+Uf	positive sense lead	rose
-Uf	negative sense lead	grey

Pressure load : positive output signal.

Shield - transparent.

accessories

	Description	Description
	Calibration Certificate kn/20/5	Factory calibration certificate for force to 20 kN in accordance with DIN EN ISO / IEC 17025 and ISO 9000 for test materials monitoring according to DIN ISO 9001: 2008 with 5 load levels and 3 series of measurements. Compressive Force
	GSV-1H	Measuring amplifier in top-hat rail housing for sensors with strain gauges. Analogue output -10V...+10V, limiting frequency 250Hz, 4 input sensitivities from 2.0mV/V.
	GSV-2TSD-DI	Measuring amplifier in desktop-housing for sensors with strain gauges. Serial port RS232, USB port, analogue output -5V...+5V, limiting frequency 260Hz, input sensitivity 3.5mV/V.
	GSV-3USB	Measuring amplifier in aluminum housing for sensors with strain gauges. Limiting frequency 1250Hz, input sensitivity 2 / 3,5 / 10 mV/V.
	GSV-6K	Analogue measuring amplifier in plug housing for sensors with strain gauges. Analogue output configurable, TEDS, sampling frequency 10Hz ... 25kHz, input sensitivity configurable 0.1mV/V ... 8mV/V
	Rod End Mx	Rod End with male thread M20x1.5, Hole Diameter 20 -0,010, Thread: right, Height: 104,5 mm, Application: for KD9363s 2,5t ... 5,0t and KD80s 20kN, 50kN

Order options

Type	Description
KD80s	stainless steel, temperature range -10 ... +70 °C (standard type)
KD80s HT	stainless steel, temperature range -20 ... +150 °C